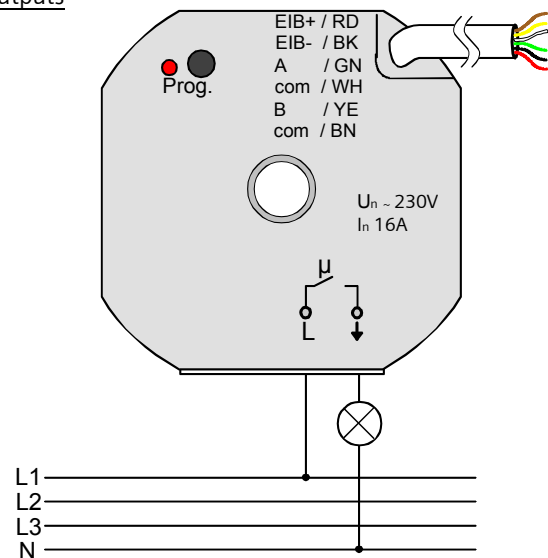
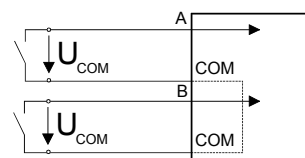
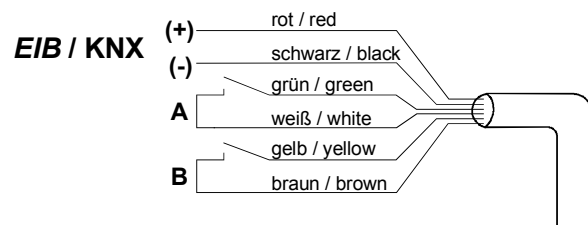

Switch Actuator UP 511/10
5WG1 510-2AB10
Product and function description

The switch actuator receives telegrams from sensors via the Instabus and switches electric loads with its relay contact. In addition, the device has two extension inputs that depending on parameter settings, can act directly on the switching output (local operation of the switching output by input A) or alternatively also as binary inputs on the Instabus. The connected potential-free switch or push button contacts are read in via a common reference potential on the switch actuator. As binary input, telegrams can be transmitted for switching or dimming, for Venetian blind control, value setting or scene recall / save.

Application program
Connection example
Outputs

Inputs

 $U_{com} = -19 \text{ V (ca./approx.)}$

Switch Actuator UP 511/10**5WG1 510-2AB10****Technical data****Voltage supply**

Carried out via the bus line

Control elements

1 learning button:

For switching between normal operating mode and addressing mode

Display elements

1 red LED:

For monitoring bus voltage and for displaying normal mode/addressing mode

Outputs

- Number: 1 output, potential-free relay contact (μ -contact) NO switch, bistable
- Rating voltage: AC 230V, 50 ... 60 Hz
- Nominal switching current: 16 A
- Max. starting current: 400A, 20ms
- Switching power:

| | |
|--------------------------|--------------------------------|
| Lamps: | 2.500W |
| HV halogen: | 2.200W |
| NV halogen: | |
| Lapped transformers: | 1000VA |
| Electronic transformers: | 1000W |
| Capacitive load: | 230V AC, 10A, max. 105 μ F |
- Switching behavior:
 - Can be parameter set, depending on function

Contacts

- Output:
 - load circuit:
 - Contact the load on 2 x H07V-K 1,5 mm² (brown) with the attached clamp.
- Inputs and bus line:
 - Line YY 6x0.6 mm
 - Approx. 33cm pre-assembled, can be laid to max. 5m

Mechanical specifications

- Housing: plastic
- Dimensions: d = 53mm, height = 28 mm
 - Opening for ceiling canopy: d = 7mm
- Weight: approx. 70 g
- Installation: in box mounts, \varnothing 60mm, depth: 40mm

Electrical safety

- Protection (according to EN 60529): IP 20

Environmental specifications

- Ambient operating temperature: - 5 ... + 45°C
- Storage temperature: - 25 ... + 70°C
 - (Storage above +45°C reduces the service life)

Electrical safety

- Degree of pollution (according to IEC 60664-1): 2
- Type of protection (according to EN 60529): IP 20
- Overvoltage category (according to IEC 60664-1): III
- Bus: Safety extra-low voltage SELV DC 24 V
- Device complies with EN 50090-2-2

EMC requirements

- Complies with EN 50090-2-2 and EN 61000-6-2

Environmental conditions

- Climatic withstand capability: EN 50090-2-2
- Ambient operating temperature: - 5 ... + 45 °C
- Storage temperature: - 25 ... + 70 °C
- Rel. humidity (not condensing): 5 % to 93 %

Markings:

KNX EIB

CE mark

In accordance with the EMC guideline (residential and functional buildings), low voltage guideline

Switch Actuator UP 511/10

5WG1 510-2AB10

Position and function of the display and operating elements

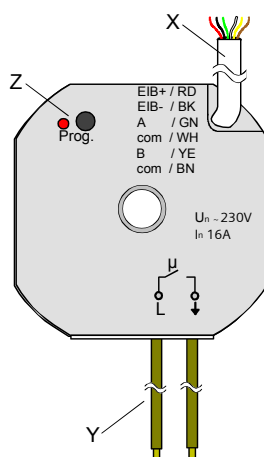

- X Connector cables low voltages
 Red: Bus (+)
 Black: Bus (-)
 Green: input A
 White: Reference potential (com)
 Yellow: Input B
 Brown: Reference potential (com)
- Y Connector cables load
 2 x brown: L and ↓ (switch output)
- Z Program button / -LED (red)

Installation and wiring

 **Danger**

- On no account should you connect mains voltage (230 V) or other external voltages to the extension inputs! Connection to an external voltage would endanger the electrical safety of the entire KNX/EIB system (SELV / no galvanic isolation)! People can be at risk, equipment and devices can be destroyed!
- During installation, ensure adequate insulation between mains voltage and bus or extensions! A minimum spacing should be maintained between bus / extension cable cores and mains voltage cable cores of at least 4 mm.
- The soldered end of lines have to connect by using the attached clamp.
- Unused cable cores of the 6-pole connection lead are to be insulated from one another and from external voltages.
- To avoid disruptive EMI irradiation, the lines of the inputs should not be laid parallel to lines conducting mains voltage.
- Input A (green), input B (yellow) and reference potential (com) (white and brown) must not connect to inputs or reference potential (com) of other devices.
- The device must only be installed and commissioned by an authorized professional electrician.
- When connecting the device, care should be taken that the device can be isolated from the mains.
- The device must not be opened.
- When planning and installing electrical equipment the relevant guidelines, regulations and specifications of the respective country must be considered.

General description

A spacing of at least 4 mm must be ensured between the low voltage lines (bus and extension inputs) and the load lines (230 V)!

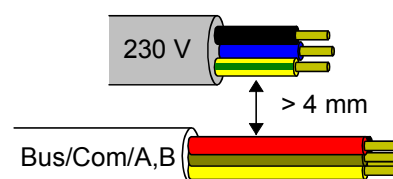

It is recommended that the switch actuator is installed in two flush sockets connected to one another. One socket (A) can accommodate, e.g., a series switch (C) as well as the bus and extension connection. The other socket (B)

Switch Actuator UP 511/10

5WG1 510-2AB10

accommodates the switch actuator and the 230 V terminals. The 6-pole connection lead (D) is guided through the socket connection.

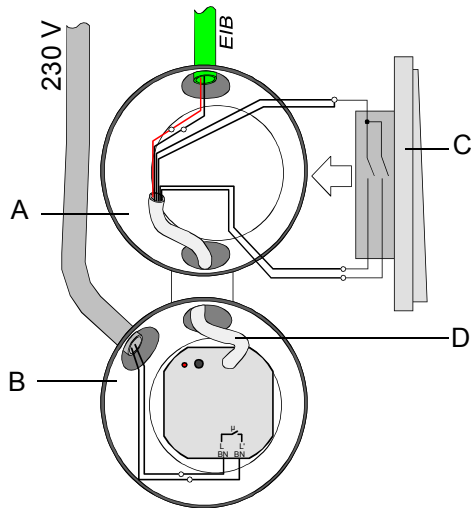

Dimension drawing

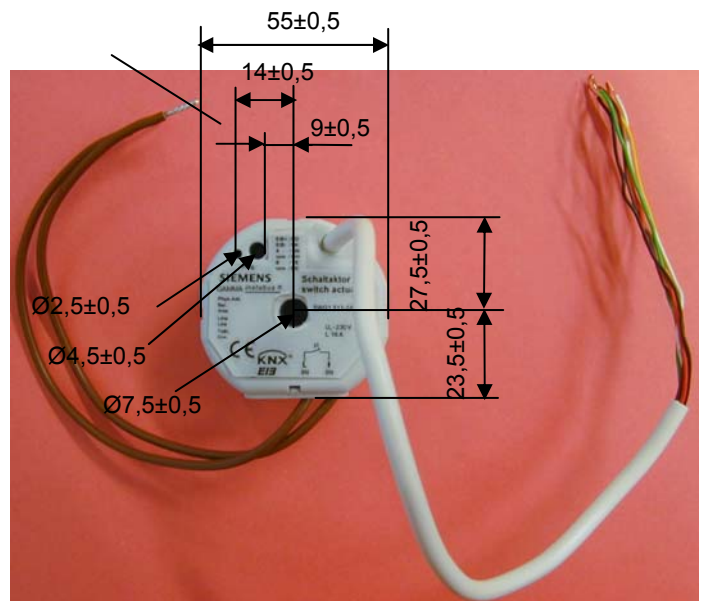
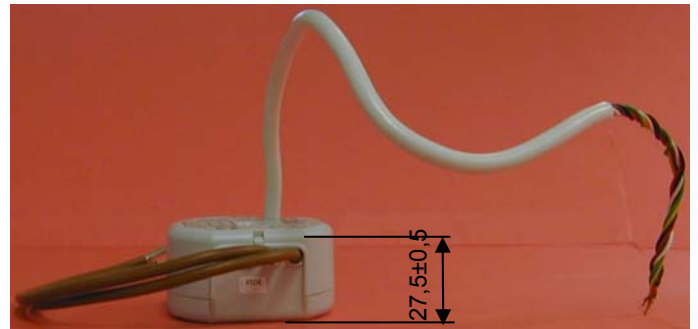

General notes

- Any faulty device should be returned to the local Siemens office.
 - If you have further questions concerning the product, please contact our Technical Support:
- +49 (0) 180 50 50-222
 +49 (0) 180 50 50-223
www.siemens.com/automation/support-request